

Chocolate Frog Wizard Card

Slight adaptation (to match my brick availability) of the original idea by Daan de Ruijter (check out his work at www.daanderuijter.nl/tutorials)

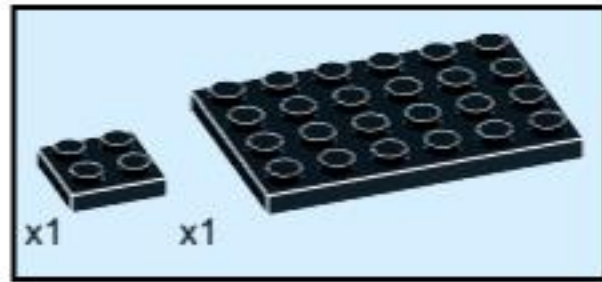

1



2

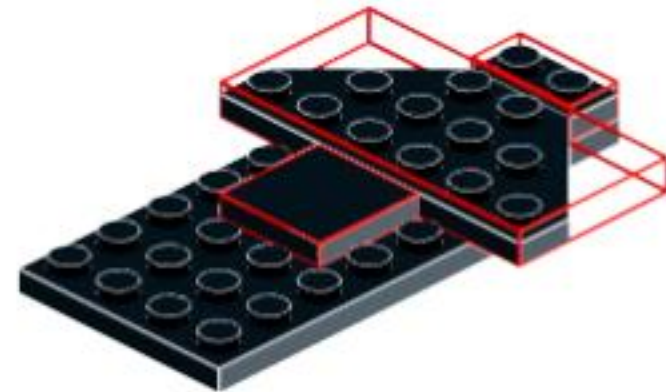
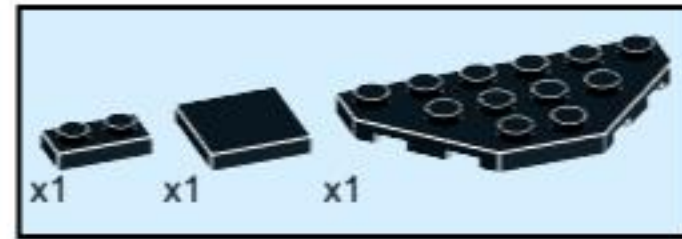

3

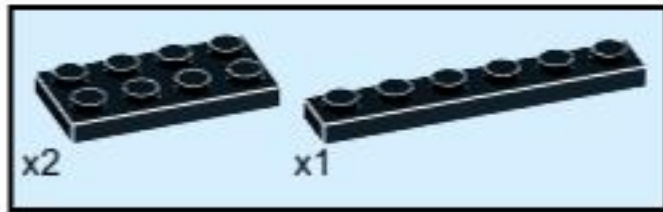

4



5

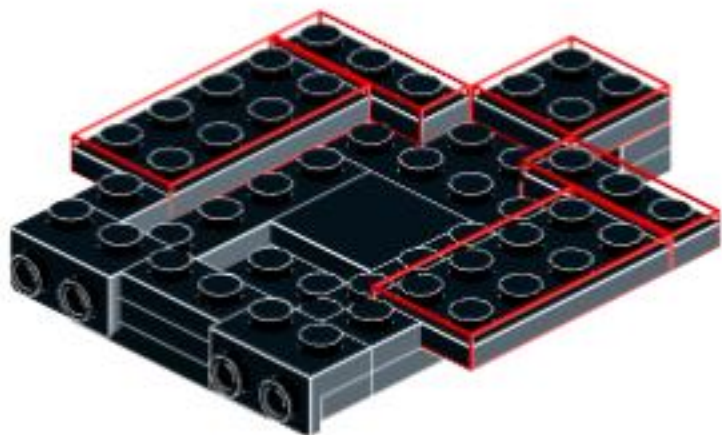

6

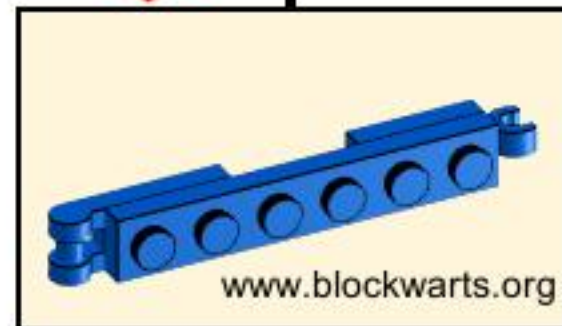
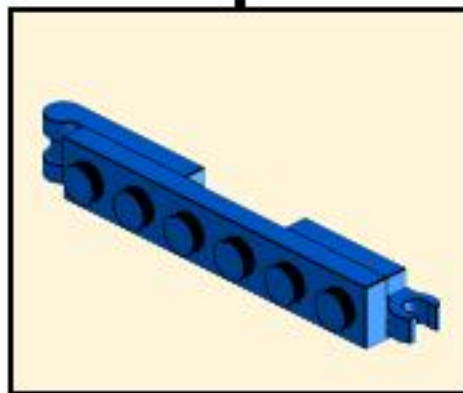
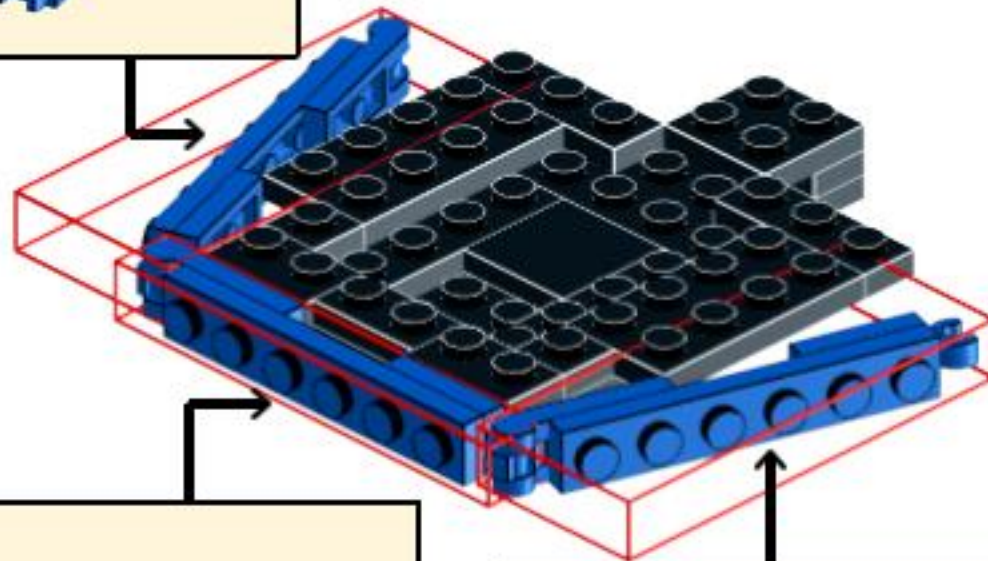
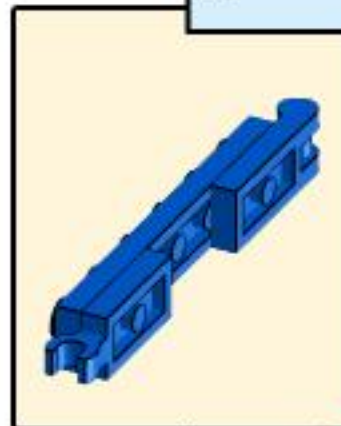
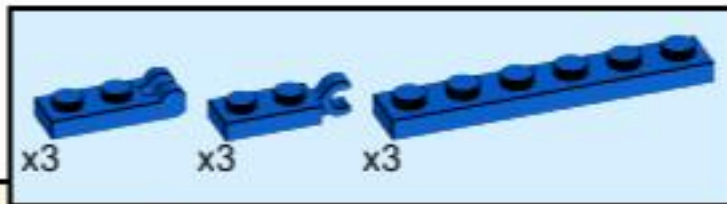

7

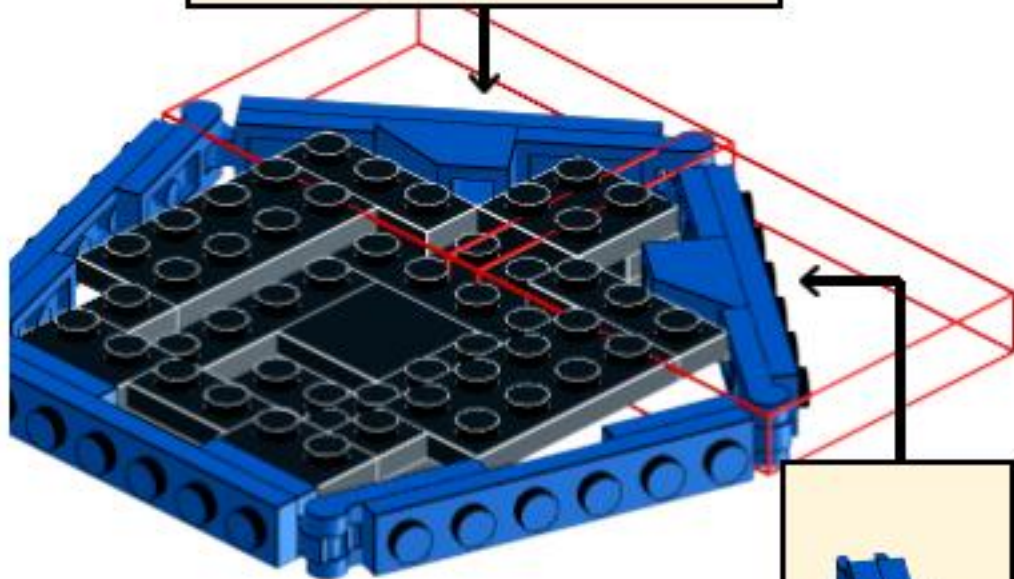
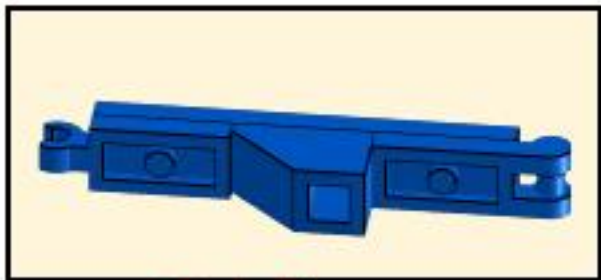
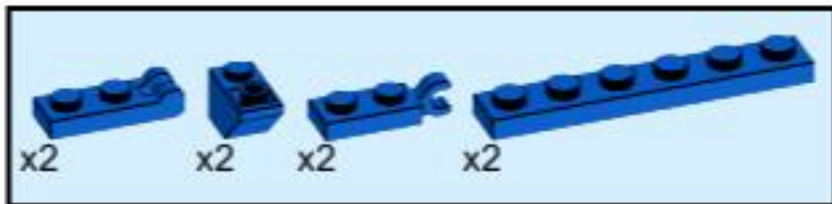

8

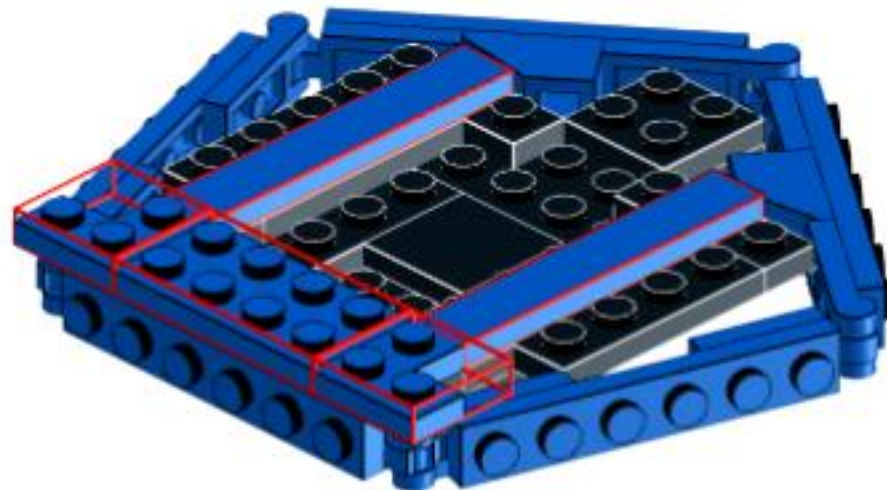
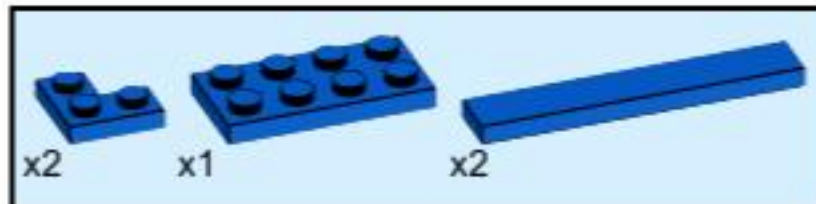

9

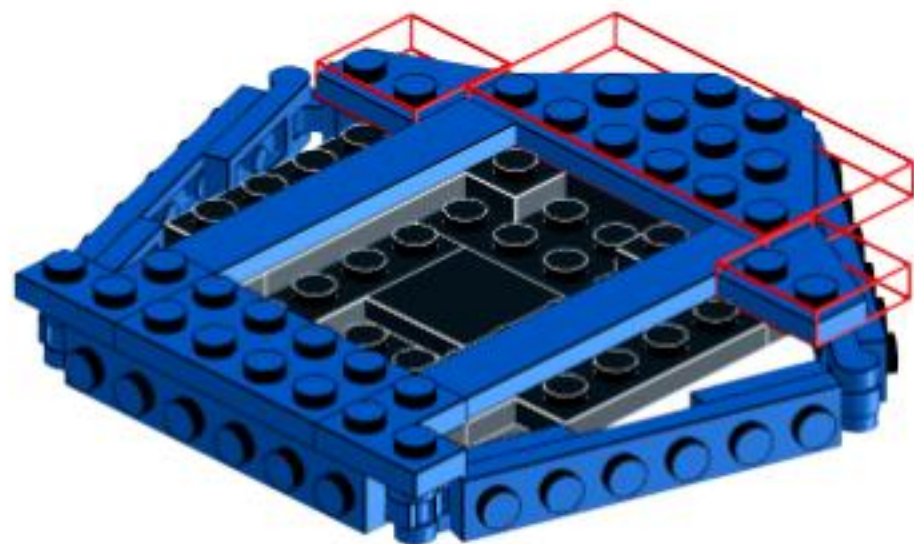
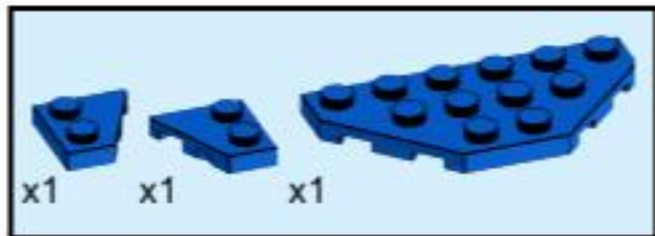

10

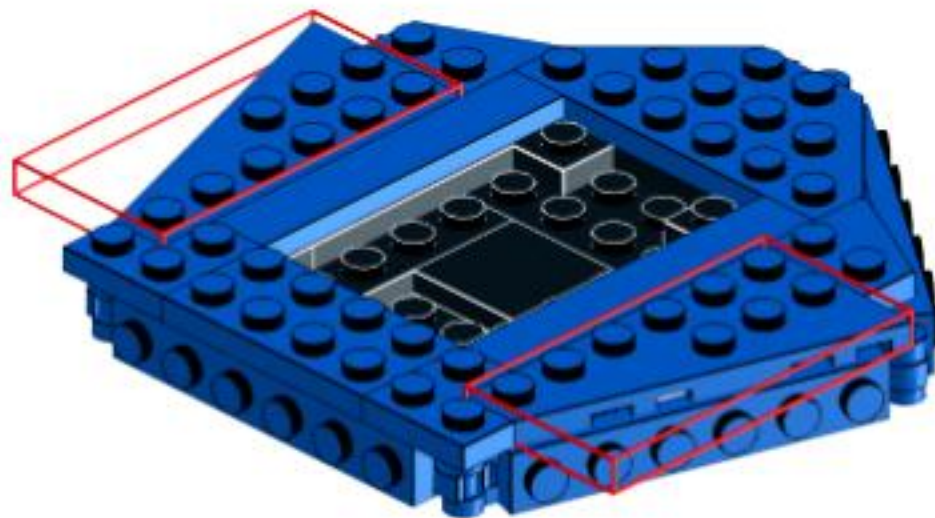
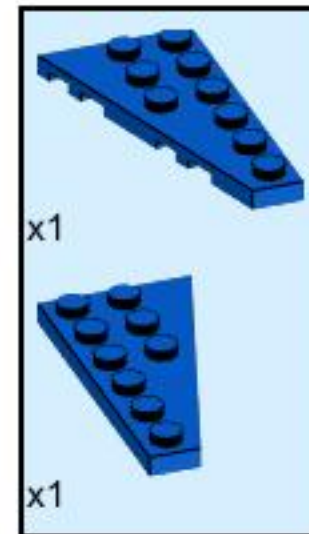

11

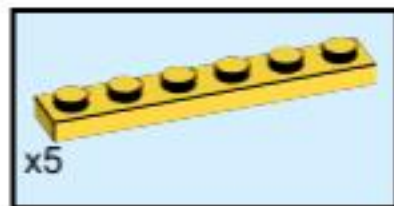

12

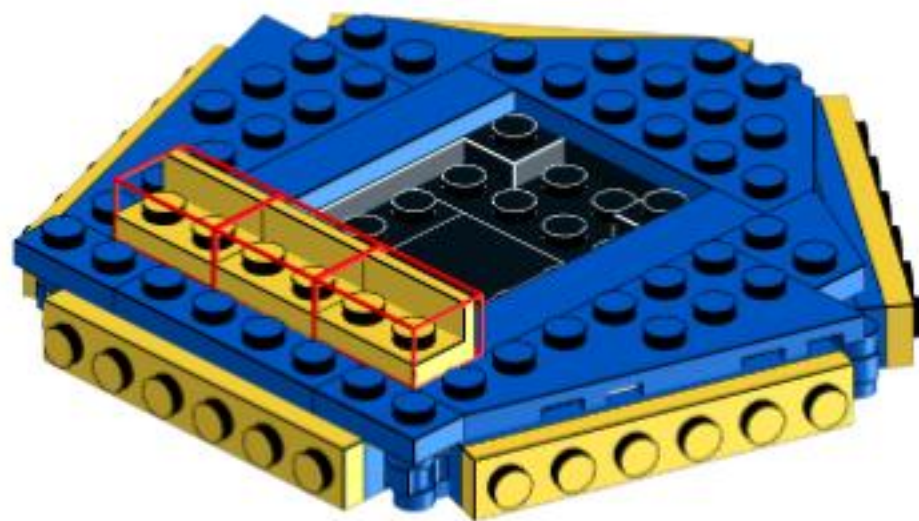

13

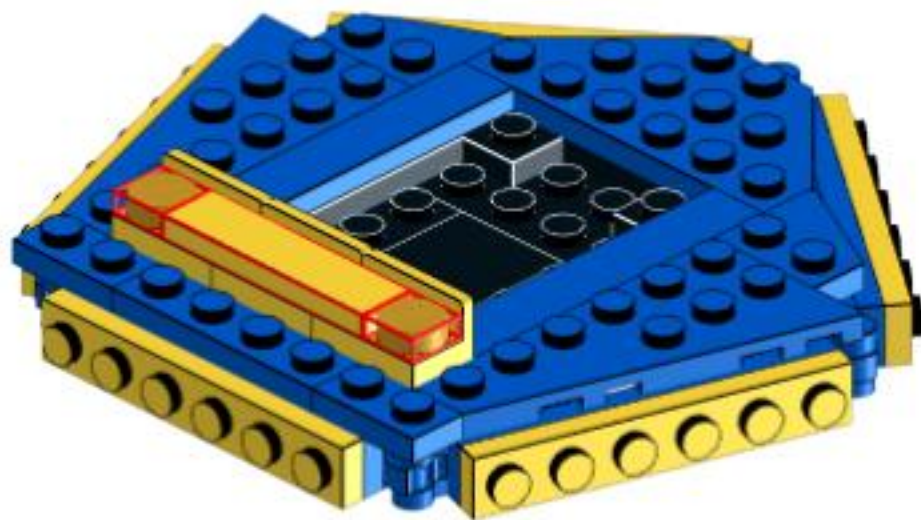
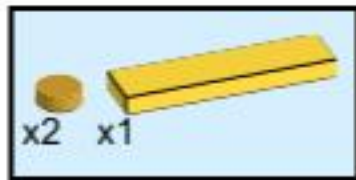

14



15

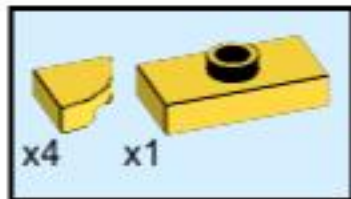

16

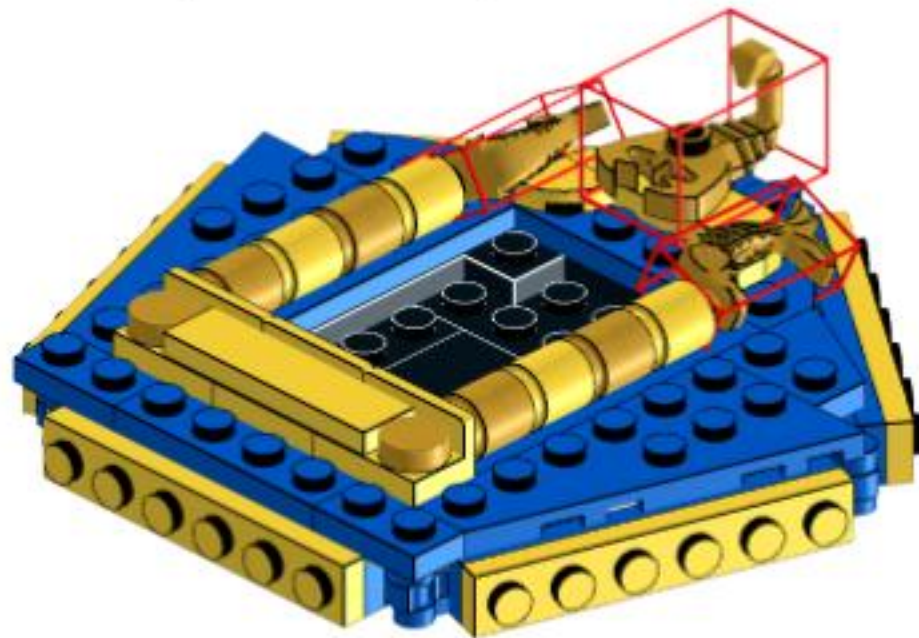
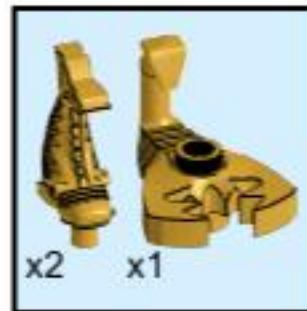

17

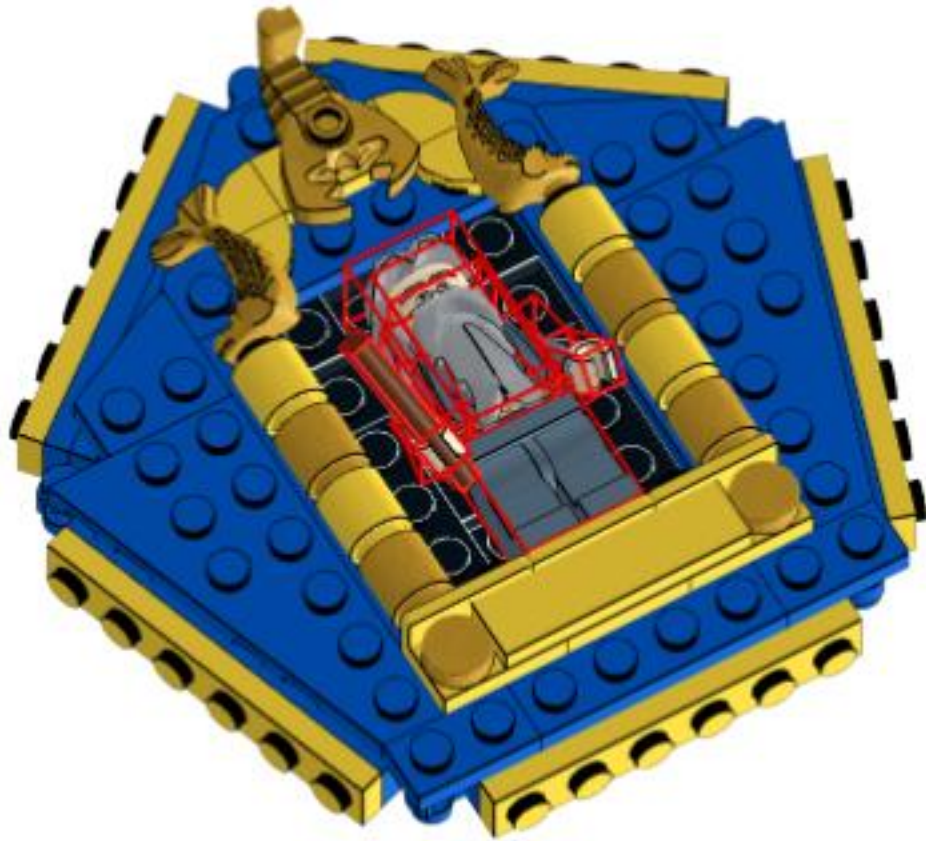

18

